



POWERMAX® HIGH PERFORMANCE COMMERCIAL POOL HEATERS



When performance is critical, the PowerMax heater provides peak efficiency and easy maintenance in both indoor and outdoor applications. Models range from 500-2000 MBTU/h with 85% efficiency for commercial swimming pool and theme park applications.

Today's PowerMax heater is the result of over 50 years of design and manufacturing experience and is packed with advanced features specific to the commercial swimming pool and water theme park market.

Available in seven sizes from 500 to 2000 MBTU/h, the PowerMax heater runs reliably on natural or LP gas and delivers efficiency levels up to 85%.

A 10-tube heat exchanger uses finned tubing for the quickest and most efficient heat transfer, and the water heater meets the ASHRAE 90.1 standard for efficiency for use with storage tanks. With superior overall construction and high-efficiency combustion, the PowerMax heater can cut fuel costs significantly compared to conventional water-heating systems, and the savings can amount to thousands of dollars over the life of the equipment.

STANDARD FEATURES

- Reliable operation with natural or propane gas.
- Fan-assisted and filtered combustion air.
- Dual-ignition systems for all models over 750,000 BTU.
- Two-stage, three-stage and four-stage firing.
- Immune to thermal shock down to 30° F.
- Built-in automatic mixing system reduces condensation possibilities.
- Compact size allows the PowerMax heater to fit through standard doorways.
- 200/208 and 575 volt models available on request.
- Meets low NOx requirements for cleaner combustion.
- One-year limited warranty. See warranty for details.

POWERMAX[®] HIGH PERFORMANCE COMMERCIAL POOL HEATERS

Dimensional Data

Dimensions shown in inches, cm.

Size (000s)	A	B	C	D	E	F	G	H	Air Conn. W*	Vent Conn. V*	Horiz. Vent Pipe											
500	33½	85	15¾	40	5¾	15	29¾	76	32¾	83	7¾	20	8¾	22	46	117	6	15	8	15	6	15
750	45½	116	21¾	55	5¾	15	29¾	76	32¾	83	7¾	20	8¾	22	58	147	6	15	10	20	8	15
1,000	57½	146	28¾	73	5¾	15	29¾	76	32¾	83	7¾	20	7	18	70	178	8	20	10	25	8	20
1,250	68	172	34	86	10¼	26	30¾	78	29½	75	8¾	22	8¾	22	80	203	8	20	12	30	8	20
1,500	78½	199	39¾	101	10¼	26	30¾	78	29½	75	8¾	22	8¾	22	91	231	8	20	12	30	8	20
1,750	89	226	44½	113	10¼	26	30¾	78	29½	75	8¾	22	8¾	22	101	256	8	20	14	36	8	20
2,000	99½	253	49¾	126	10¼	26	30¾	78	29½	75	8¾	22	8¾	22	112	284	12	30	14	36	12	30

*Air and vent connections may be on top or back of the PowerMax heater and are field convertible.

Sizing Data

Indoor Model	Input, BTU/h x1000	Output, BTU/h x1000	Gas Conn. Size (inches ₂)	Heater Water Conn. Size (inches ₂)	Mixing System Water Conn. Size (inches ₂)	Shipping Weight	
						lbs.	kg
500	500	425	1¼	2	2	495	225
750	750	638	1¼	2	2	575	261
1,000	999	849	1½	2½	2	685	311
1,250	1,250	1,063	2	2½	2	730	331
1,500	1,500	1,275	2	2½	2	830	377
1,750	1,750	1,488	2	2½	2	880	400
2,000	1,999	1,699	2	2½	2	1,025	465

NOTES: 1. Input and output must be derated 2% per 1,000 feet above sea level when installed above 2,000 feet altitude.
2. Dimensions are nominal.

DIMENSIONAL AND SIZING DATA

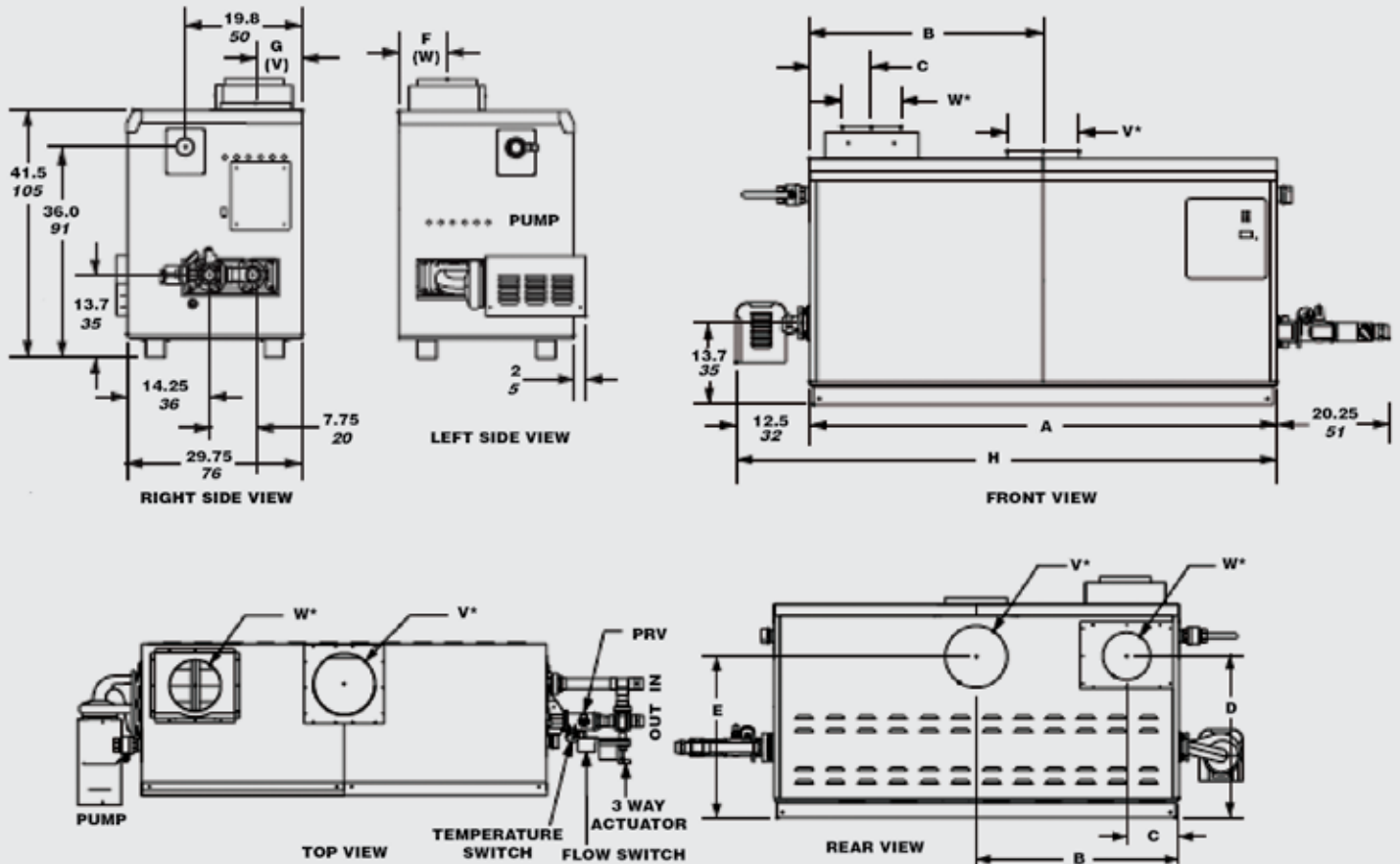

SIZING CHARTS AND CLEARANCE DATA

For Indoor Pools

1. Calculate the surface area of the pool in square feet.
2. Refer to the selection chart.
3. Find the closest square footage in the 10° F (6° C) Temperature Difference table and the heater model that corresponds to it.
For normal conditions, we recommend using the 10° F (6° C) Temperature Difference columns; this will provide a temperature increase of approximately 6° F (3° C) per 24-hour period.

For Outdoor Pools

1. Determine the difference between the desired pool temperature and the average air temperature during the coldest month in which the pool will be used (see the Temperature Difference table below).
2. Calculate the surface area of the pool.
3. Refer to the selection chart. Listed are the maximum pool surface areas for each heater model with typical temperature differences. Make the appropriate selection from the chart.

Temperature Difference

	10° F	6° C	15° F	8° C	20° F	11° C	25° F	14° C	30° F	17° C	35° F	19° C	40° F	22° C	45° F	25° C	50° F	28° C
	Surface Area of Pool																	
Model	Sq. Ft.	Sq. M.	Sq. Ft.	Sq. M.	Sq. Ft.	Sq. M.	Sq. Ft.	Sq. M.	Sq. Ft.	Sq. M.	Sq. Ft.	Sq. M.	Sq. Ft.	Sq. M.	Sq. Ft.	Sq. M.	Sq. Ft.	Sq. M.
500	4,090	370	2,720	250	2,040	180	1,630	150	1,360	120	1,170	100	1,020	90	910	80	810	70
750	6,130	560	4,090	370	3,060	280	2,450	220	2,040	180	1,750	160	1,530	140	1,360	120	1,220	110
1,000	8,180	750	5,450	500	4,090	370	3,270	300	2,720	250	2,340	210	2,040	180	1,820	160	1,630	150
1,250	10,230	950	6,820	630	5,110	470	4,090	370	3,410	310	2,920	270	2,550	230	2,280	210	2,040	180
1,500	12,270	1,130	8,180	750	6,130	560	4,910	450	4,090	370	3,510	320	3,060	280	2,730	250	2,450	220
1,750	14,320	1,330	9,540	880	7,160	660	5,720	530	4,770	440	4,090	370	3,580	330	3,190	290	2,860	260
2,000	16,370	1,520	10,910	1,010	8,180	750	6,540	600	5,450	500	4,680	430	4,090	370	3,650	330	3,270	300

Clearances

Appliance Surface	Clearance From Combustible Material	Service Access Clearance
Right Side	1" 2.5 cm	24" 61 cm
Left Side	1" 2.5 cm	24" 61 cm
Front	1" 2.5 cm	36" 91 cm

Appliance Surface	Clearance From Combustible Material	Service Access Clearance
Top	1" 2.5 cm	12" 30 cm
Back*	1" 2.5 cm	12" 30 cm
Vent	Per venting system supplier's instructions	

*When vent and/or air is connected to the back, 36" (91 cm) is suggested.

Part Numbers Descriptions

PM0500NACC2BXN	Indoor/Outdoor, w/pump, Cat. I-III, with elec. Bypass, Cl-Cu HX
PM0750NACC2BXN	Indoor/Outdoor, w/pump, Cat. I-III, with elec. Bypass, Cl-Cu HX
PM1000NACC2BXN	Indoor/Outdoor, w/pump, Cat. I-III, with elec. Bypass, Cl-Cu HX
PM1250NACC2BXN	Indoor/Outdoor, w/pump, Cat. I-III, with elec. Bypass, Cl-Cu HX
PM1500NACC2BXN	Indoor/Outdoor, w/pump, Cat. I-III, with elec. Bypass, Cl-Cu HX
PM1750NACC2BXN	Indoor/Outdoor, w/pump, Cat. I-III, with elec. Bypass, Cl-Cu HX
PM2000NACC2BXN	Indoor/Outdoor, w/pump, Cat. I-III, with elec. Bypass, Cl-Cu HX
PM0500NACC2PXN	Indoor/Outdoor, w/pump, Cat. I-III, with elec. Bypass, Cl-Cu-Ni HX
PM0750NACC2PXN	Indoor/Outdoor, w/pump, Cat. I-III, with elec. Bypass, Cl-Cu-Ni HX
PM1000NACC2PXN	Indoor/Outdoor, w/pump, Cat. I-III, with elec. Bypass, Cl-Cu-Ni HX
PM1250NACC2PXN	Indoor/Outdoor, w/pump, Cat. I-III, with elec. Bypass, Cl-Cu-Ni HX
PM1500NACC2PXN	Indoor/Outdoor, w/pump, Cat. I-III, with elec. Bypass, Cl-Cu-Ni HX
PM1750NACC2PXN	Indoor/Outdoor, w/pump, Cat. I-III, with elec. Bypass, Cl-Cu-Ni HX
PM2000NACC2PXN	Indoor/Outdoor, w/pump, Cat. I-III, with elec. Bypass, Cl-Cu-Ni HX

NOTE: Other models, including those that meet CSD-1 requirements, and propane gas models are available. Contact factory for details.



POWERMAX®

HIGH PERFORMANCE COMMERCIAL POOL HEATERS

Packed With Advanced Features

Every PowerMax heater comes standard with a built-in automatic mixing system to make sure low return water temperatures won't cause problematic condensation in the heat exchanger. The mixing system includes an automatic three-way valve, fast-acting electronic actuator, factory mounted and wired pump, and a simple operating control that monitors all important system functions.

That means the PowerMax heater can handle return water temperatures as low as 60 degrees without condensation. And, every PowerMax heater has a standard "Backwash Switch" that allows you to safely backwash the filter and avoid high-limit shutdowns by allowing the pump time delay to complete its cycle before shutting down the heater. NOx emissions are among the lowest in the industry at 10 ppm, and the PowerMax heater maintains its efficiency and low NOx levels at all stages of firing.

Easy to Install and Service

The PowerMax heater makes service easy and operation reliable, because we do all of the setup for you. Whether you use room air for combustion or take air from outside, vent into a chimney or through a sidewall, or install the heater indoors or outside, the PowerMax heater is ready "out of the box." The automatic bypass and combustion systems are factory preset, and no field adjustments are required. Whether you are installing at sea level or at a 10,000-foot elevation, no orifice or component changes are needed.

We've also taken service access to a new level. The PowerMax heater makes installation easier by providing a control system that gives installers several different operation modes, selected with the touch of a button. Modes include settings for primary/secondary piping, DHW storage tank systems, B.A.S. controls and other common applications.

The PowerMax heater features convenient, modular construction that separates the burner trays, gas train and blower assembly to ensure perfect alignment of orifices and burners. Gas manifolds mount on the burner flange, and the burner flanges seal to the air box. In addition, the entire gas train can be easily removed, and the heat exchanger simply lifts out from the top or front of the unit. The air filter is a breeze to clean...just wash it with soap and water.

Controls are also service friendly with clean and simple wiring and are readily accessible in a slide-out drawer. All models have a convenient, front-access panel with status indicator lights to monitor power, call for heat, pump on, ignition on, gas valve open and lock out.

Installation and Service Convenience Features

- Reversible vent and intake air terminals (field convertible).
- Gas supply right or left side (field convertible).
- Reversible water connections to accommodate left or right side piping.
- Separate field-wiring terminal panel.
- Front panel diagnostics.
- Optional rack mounting.
- Quick-access panel for igniter replacement.
- Combustion chamber sight glasses on both right and left sides.



1620 HAWKINS AVE, SANFORD, NC 27330 800.831.7133 WWW.PENTAIRCOMMERCIAL.COM

All Pentair trademarks and logos are owned by Pentair or one of its global affiliates. PowerMax® is a registered trademark of Pentair Water Pool and Spa, Inc. and/or its affiliated companies in the United States and/or other countries. Because we are continuously improving our products and services, Pentair reserves the right to change specifications without prior notice. Pentair is an equal opportunity employer.

7/15 Part # P1-354 ©2015 Pentair Water Pool and Spa, Inc. All rights reserved.

