

Raypak[®]
A Rheem[®] Company

AVIA[®]

The first and only pool/spa heater
with a built-in advanced Wi-Fi
enabled control system!



AVIA[®]

POOL AND SPA HEATER



EXCLUSIVE HEAT
EXCHANGER TECHNOLOGY



Easy to Install | Strength & Durability | Mobile App Control



PROUDLY BASED IN THE U.S.A



HEAT SMARTER PLAY HARDER

Managing your pool heater has never been easier. AVIA is built with an innovative Wi-Fi enabled control system that allows you to manage your pool heater through our Raymote® Mobile App. No need for a separate control panel to manage your pool heater.



KEY FEATURES:



Heater Control voc

All controls are built right into the AVIA. Enabling you to automate and manage your pool temperature with ease.



Scheduling voc



AVIA estimates heating time by factoring in your pool size and set temperature, gradually learning the optimal heating duration over time.



Operation Manager voc

Manage your heater and one accessory.



Integrated Wi-Fi voc

Provides cloud connection for real-time service alerts and control from anywhere.



ProTek Shield™

A replaceable module that protects the heat exchanger and extends the life of the unit.

voc Voice of the Customer

*360 degrees on AVIA® is applicable when vent side is ducted.



Raymote®

Temperature & Heater Control voc

Raymote Mobile App allows you on-the-go control of your pool temperature and more.



Small & Easy to Install voc

AVIA weighs under 140 pounds and has a base foot print of 2'x2' making it an ideal install on a standard equipment pad.



Installation Versatility voc

AVIA's top with control panel can be rotated 360° giving you more installation options.*



Serviceability

AVIA's patented straight tube heat exchanger design makes it the most serviceable in the market.



Efficiency

All AVIA models have an 84% thermal efficiency rating and are Low NOx certified.

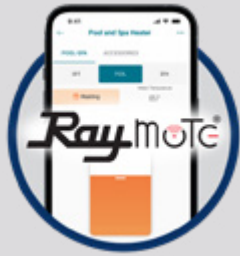

MOBILE APP CONTROL

Integrated Wi-Fi and Raymote® Temperature Control

Connect via a mobile device for real-time service alerts and scheduling. Raymote Mobile App allows you full control of your pool heater, set your temperature from anywhere.



SELF-PROTECTION TECHNOLOGY



ProTek Shield™

A cutting-edge module that cuts down galvanic corrosion to the heat exchanger due to ionic migration. Excellent for use in pools sanitized by salt water chlorination.

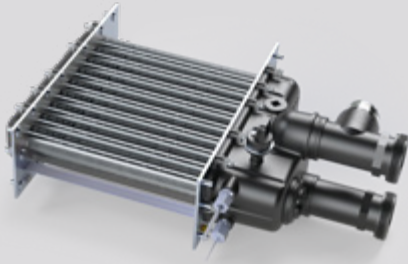

STRAIGHT TUBE HEAT EXCHANGER



Straight tube design on both copper and NiTek™ models

Our heat exchangers last longer thanks to our straight tube design. By eliminating bends and helical coils we have reduced unnecessary friction in critical areas.

DROP-IN REPLACEMENT

AVIA water and gas connections line up for easy drop-in replacement. The lightweight design, small footprint, and 360° top rotation makes for easy install and quick serviceability.

Scan the QR code to download the full Drop-In Replacement guide and upgrade to an AVIA today!

SCAN HERE





CONTROL FROM ANYWHERE

You can also control your AVIA settings from across the street — or across town — right from your phone. Whether adjusting the pool heater temperature or checking on heater status, it's all possible through your Raymote remote Wi-Fi connection.



24/7 Access

Remotely monitor your pool or spa heaters from anywhere, anytime, with touch-of-a-button access.

Stay Informed

Real-time updates notify you of any service or maintenance needs so your heater and pool are always ready to be used.

Heater Control

AVIA's heater control within the Raymote App makes it easy to manage your pool/spa and keep it at the perfect temperature.

Route Management

Track heater status and service alerts to help dispatch technicians and/or schedule daily, weekly routes.

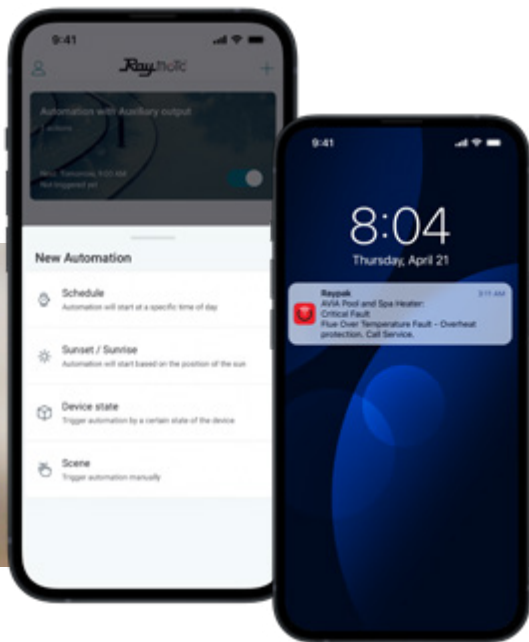

Download the free Raymote Mobile App today!



STRAIGHT FORWARD CONTROLS

AVIA is built with a sophisticated control system that allows you to manage your heater through its easy to use, capacitive touch control interface.

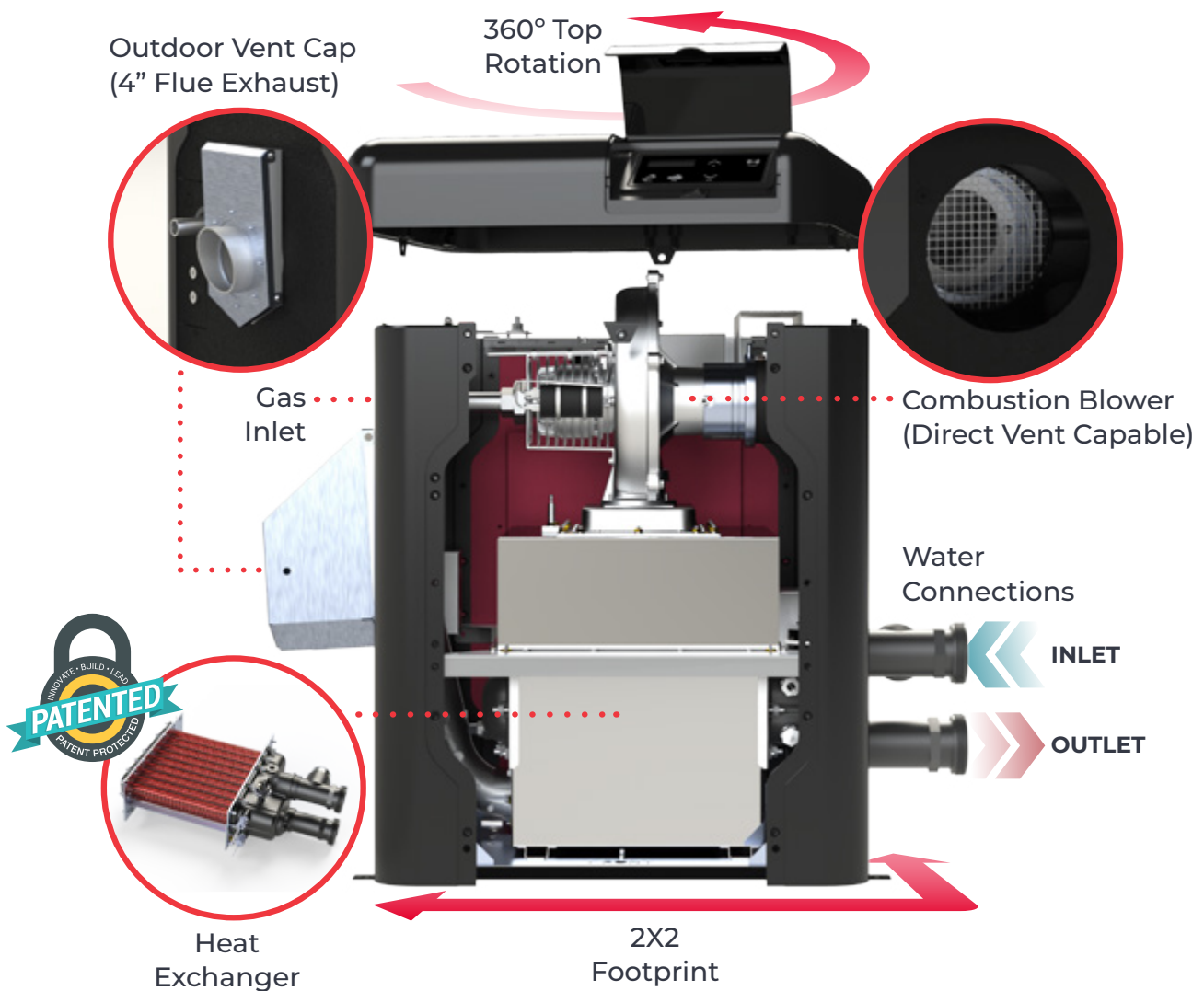
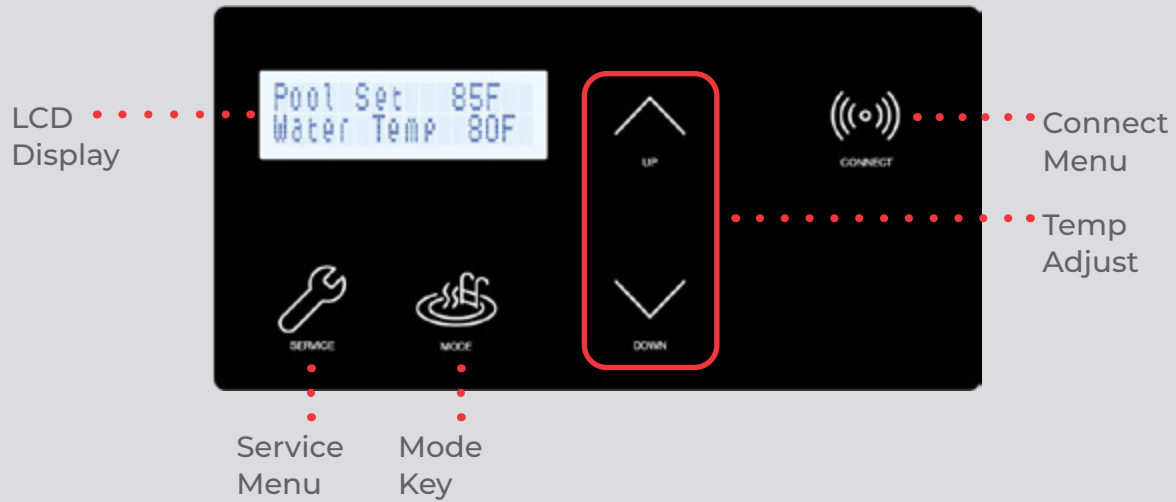

With three patents and two patents pending, AVIA is the most innovative product on the market!



HEAT WITH EFFICIENCY

SUSTAINABILITY

As a member of the Rheem® family of brands, Raypak® is committed to taking a greater degree of responsibility for future generations. To learn more about our sustainability initiatives, visit

Raypak.com/Sustainability



CO2 IMPACT INDICATOR



13 million+
TREES SAVED

Choosing this product instead of a minimum efficiency alternative offsets CO2 emissions equivalent to planting this number of trees over the product's lifetime.

** Since 2019 the amount of CO2 savings for all products is equal to 13 million trees... and growing!*

The CO2 Impact Score

The reduced CO2 impact of selecting a high efficiency Raypak product instead of a minimal efficiency alternative is reflected in the product's CO2 impact score. This score provides a simple means of measuring the

reduced CO2 emissions compared with a minimal efficiency alternative. The CO2 Impact Score is internally calculated based on a typical product lifetime and does not denote a third party certification/seal.



Max efficiency is assumed for all units at all times for all Treescore calculations. Total environment benefit numbers are achieved by multiplying benefit/yr with Heat-exchanger or Thermal-shock warranty to get total benefit over the course of life of the product. Values used for CO2 emitted per million BTUs are 117lb for NAT GAS, 139lb for PROPANE. US electrical grid's average carbon footprint of 270lb/million BTUs is used as electricity carbon footprint. Runtime for units is assumed to be: Pool= 1600hrs/year, Commercial=2000hrs/year. All products are compared to their min. efficiency counterparts based on application/ use. (Example: HPPH is compared to NAT GAS Pool heater). For all calculations heaters with same BTU rating (heating capacity) are compared to baseline heaters with min. efficiency as per US regulatory authorities. Treescore is calculated based on lesser CO2 emitted by our products vs CO2 absorbed by trees. (CO2 absorbed over 10years by a new average seedling planted today is 132.27lb). Lesser CO2 emitted calculations exclude CO2 footprint of building and recycling the product. Environmental benefit is only applicable for the time for which the higher efficiency product is used by customer.



INDUSTRY FIRST TECHNOLOGY

LONGEVITY

NiTek reduces more than 50% scale formation¹ and has 900% more nickel compared to cupronickel in critical surfaces.²

EFFICIENCY

NiTek produces up to 2% more thermal efficiency than cupronickel, and the same thermal efficiency as copper.³

STRENGTH

NiTek is 300% more erosion resistant than copper, and 200% more than cupronickel.⁴

300% more erosion resistant than copper

200% more than cupronickel

NiTek



CuNi

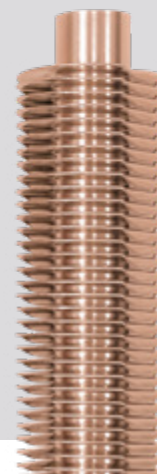

Cu



Disclaimers:

1. Hardwater : CaCO₃ content of 386 PPM has been used as the criteria for hardwater. Based on hardwater scale testing (CaCO₃ content of 386 PPM). Based on lab reliability data.

2. Based on material composition information from Raypak Series XXII Cu-Ni product, AVIA HD (Ni-coated) greater than 90% vs 10%.

3. Based on the thermal efficiency testing collected with AVIA Ni-coated samples vs Raypak series XXII CU-Ni.

4. Based on ASTM G73-10 (2017) – material durability (liquid impingement erosion test).

POOL & SPA HEATER

MODELS 264A & 404A

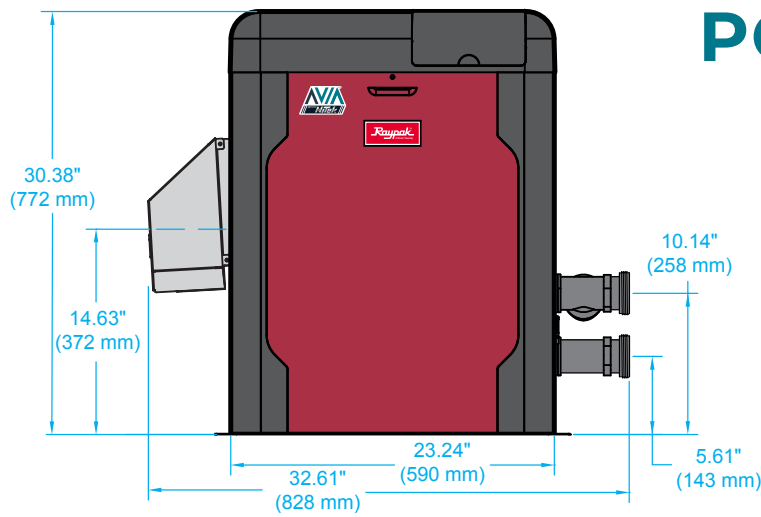

LEFT SIDE

FRONT

RIGHT SIDE

Stack
3 pallet
high MAX

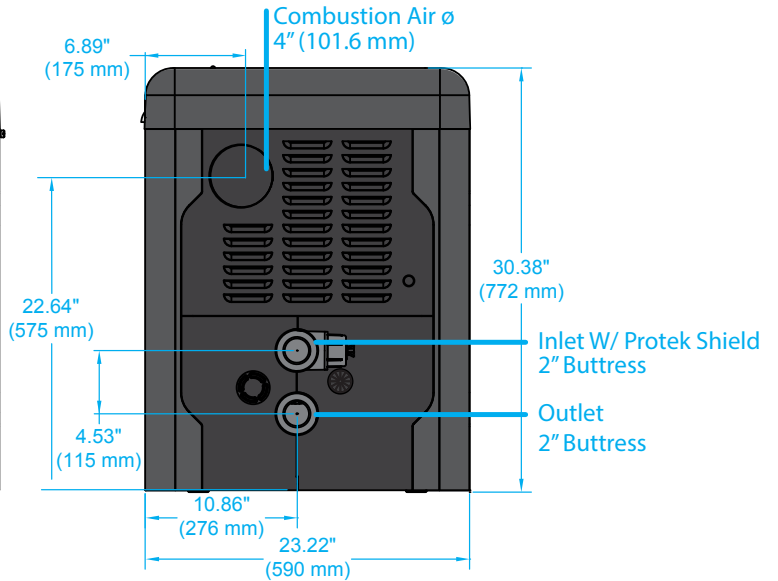
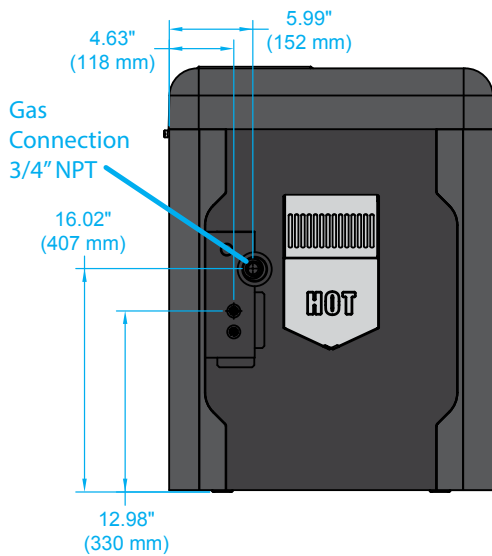
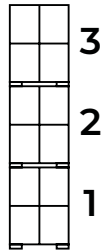

Model No.	Part No.	MBTUH Input (kWh)	Thermal Efficiency %	Gas Type	ELEVATION FT. *	Flue ø in. (mm)	Unit Weight lbs. (kg)	Shipping Weight lbs. (kg)
NiTek Heat Exchanger								
P-R264A-EN-N	018044	264 (77.4)	84	Natural	0-10000	4 (101.6)	135 (61.2)	155 (70.2)
P-R264A-EP-N	018050	264 (77.4)	84	Propane	0-4500	4 (101.6)	135 (61.2)	155 (70.2)
P-R404A-EN-N	018045	399 (116.9)	84	Natural	0-10000	4 (101.6)	135 (61.2)	155 (70.2)
P-R404A-EP-N	018051	399 (116.9)	84	Propane	0-4500	4 (101.6)	135 (61.2)	155 (70.2)
Copper Heat Exchanger								
P-R264A-EN-C	018032	264 (77.4)	84	Natural	0-10000	4 (101.6)	135 (61.2)	155 (70.2)
P-R264A-EP-C	018038	264 (77.4)	84	Propane	0-4500	4 (101.6)	135 (61.2)	155 (70.2)
P-R404A-EN-C	018033	399 (116.9)	84	Natural	0-10000	4 (101.6)	135 (61.2)	155 (70.2)
P-R404A-EP-C	018039	399 (116.9)	84	Propane	0-4500	4 (101.6)	135 (61.2)	155 (70.2)

* This product is approved up to 4,500 ft of elevation per CAN/CGA-2.17-M91. Rated inputs are suitable for up to 4,500 feet (1371 m) elevation. Approved up to 10,000 ft for natural gas; Liquid Propane approved to 4501-7800 ft using kit 018762F.

ProTek Shield Replacement Kit

Part No.

ProTek Shield Module

017960F

ProTek Shield Bulk Pack (25 PCS)

018847F

raypak.com/pool

2151 Eastman Avenue | Oxnard, CA 93030 | 805-278-5300

Litho in U.S.A. ©2023 Raypak, Inc.
RP-P-600-1 REV B Effective 12-18-23 | Replaces 02-15-23